



Acuvim II IO Modules User's Manual

- AXM-IO1: 6 DI, 2 RO and Power supply for DI
- AXM-IO2: 4 DI, 2 DO and 2 AO
- AXM-IO3: 4 DI, 2 RO and 2 AI

ACCUEVERGY

Copyright®2008 V1.30

This manual may not be reproduced in whole or in part by any means, without written permission of Accuenergy.

The information contained in this document is believed to be accurate at the time of publication, however, Accuenergy assumes no responsibility for any errors which may appear here and reserves the right to make changes without notice. Please ask the local representative for latest product specifications before ordering.

Please read this manual carefully before doing installation, operation and maintenance of Acuvim II meter.

Following symbols are used in this user's manual and on Acuvim II meter to alert the dangerous or to prompt in the operating or set process.



Dangerous symbol, Failure to observe the information may result in injury or death.



Alert symbol, Alert the potential dangerous. Observe the information after the symbol to avoid possible injury or death.



This mark is on product for UL Listed product.

Installation and maintenance of the Acuvim II meter should only be performed by qualified, competent personnel that have appropriate training and experience with high voltage and current device.

This document is not fit for any untrained people. Accuenergy is not responsible for any problem happens under proper operation.

Content

Chapter 1 Introduction	1
1.1 The Purpose of IO Modules.....	2
1.2 The Properties of IO Modules.....	4
1.3 List of functions of IO Modules.....	4
Chapter 2 Installation	5
2.1 Appearance and Dimensions.....	6
2.2 Installation Method.....	6
2.3 Wiring of IO modules.....	8
Chapter 3 Function of IO Modules	17
3.1 Detection of remote signals.....	18
3.2 Counter of Pulses.....	23
3.3 Relay output.....	26
3.4 Digital output.....	28
3.5 Analog Output.....	30
3.6 Analog Input.....	33
Appendix	37
Appendix A Technical Data and Specification of IO Modules	38
Appendix B Ordering Information	40
Appendix C Revision History	41

Starting!

The manual is about IO modules of Acuvim II meter, which can extend Acuvim II meter's functions largely.

Please read this manual carefully before operating or setting the Acuvim II meter to avoid unnecessary trouble. You can read part of this manual depends on how you use the Acuvim II meter and IO modules.

Chapter 1 helps you understand the fundamental function and application area of IO modules.

Chapter 2 describes in detail installation and wiring of IO modules.

Chapter 3 tells you the functions of IO modules and parameter setting method.

Appendix lists the technical data and specification and ordering information.

Chapter 1 Introduction

The Purpose of IO Modules

The Properties of IO Modules

List of Functions of IO Modules

1.1 The Purpose of IO Modules

Acuvim II meter does not have any IO functions itself, but it can realize multi IO functions with IO modules, such as digital input, counter of pulses, relay output, analog output, and analog input and so on.

There are three types of IO modules, AXM-IO1, AXM-IO2 and AXM-IO3. According to the difference in communication with Acuvim II meter, each type of IO module also has two modes, logic NO.1 and logic NO.2. That is, two of each type of IO module, one logic NO.1 and another is logic NO.2, can be linked to Acuvim II meter at one time.

AXM-IO1 module, which is adapted to low voltage power distribution, is composed of:

6 digital inputs (DI), each digital input can be used to detect remote signals, or be used as a counter of input pulses. When it is used to detect remote signals, it also can enable SOE(sequence of events), recording the event and time of the event.

2 relay outputs (RO), it can work in controlling mode, or work in alarm mode. Both of 2 relay outputs work in the same mode. When it works in controlling mode, it has two optional output modes, latching mode and pulse mode. When it works in alarm mode, it has only one latching output mode.

24V isolated power supply; it is used as an auxiliary power supply for digital inputs.

AXM-IO2 module, which is adapted to factory DCS (or processing controlling, BA), is composed of:

4 digital inputs (DI), each digital input can be used to detect remote signals, or be used as a counter of input pulses. When it is used to detect remote signals, it also can enable SOE(sequence of events), recording the events and time of the events.

2 analog outputs (AO), it can output analog voltage or analog current. When it outputs analog voltage, the range of voltage is from 0 to 5V or from 1 to 5V. When it outputs analog current, the range of current is from 0 to 20mA or from 4 to 20mA.

2 digital outputs (DO), it can work in alarm mode, or work in energy pulse output mode. Both of 2 digital outputs work in the same mode. When it works in energy pulse output mode, it can output various types of energy.

AXM-IO3 module, which is adapted to electrical devices, is composed of:

4 digital inputs (DI), each digital input can be used to detect remote signals, or be used as a counter of input pulses. When it is used to detect remote signals, it also can enable SOE(sequence of events), recording the events and time of the events.

2 relay outputs (RO), it can work in controlling mode, or work in alarm mode. Both of 2 relay outputs work in the same mode. When it works in controlling mode, it has two optional output modes, latching mode and pulse mode. When it works in alarm mode, it has only one latching output mode.

2 analog inputs (AI), it can detect input analog voltage or analog current. When it detects input analog voltage, the range of voltage is from 0 to 5V or from 1 to 5V. When it detects input analog current, the range of current is from 0 to 20mA or from 4 to 20mA.

1.2 The Properties of IO Modules

Extensibility: by linking IO modules, Acuvim II meter can extend variable IO functions.

Practicability: IO modules can be easily linked to Acuvim II meter.

1.3 List of Functions of IO Modules

Functions	AXM-IO1	AXM-IO2	AXM-IO3
Detection of remote signals	•	•	•
Recording of SOE	•	•	•
Counting of input pulses	•	•	•
Output remote controlling by relay	•		•
Output alarm by relay	•		•
Output alarm by digital output		•	
Output power pulses by digital output		•	
Analog output		•	
Analog input			•
24V isolated voltage output	•		

Chapter 2 Installation

Appearance and Dimesions

Installation Method

Wiring of IO Modules

2.1 Appearance and Dimensions

Figure 2-1 shows a structure configuration of IO module.

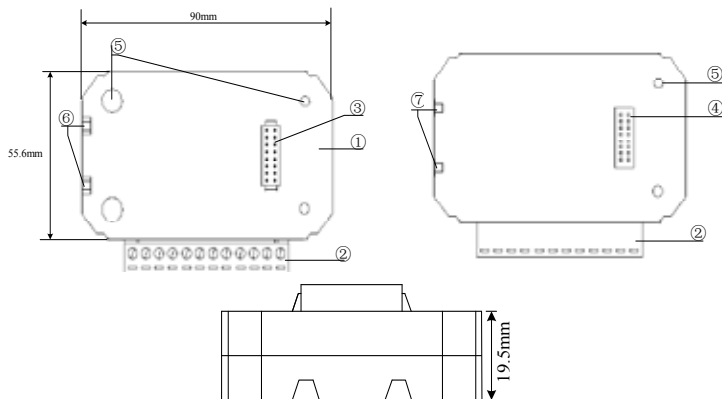

①	Enclosing	⑤	Installation screw
②	Wiring Terminals	⑥	Counterpart of clip
③	Linking pins	⑦	Installation clip
④	Linking socket		

Figure 2-1 structure configuration of IO modules

2.2 Installation Method

Environmental

Please check the environment temperature and humidity to ensure the satisfaction of Acuvim II meter and IO modules requirement before the

meter installation.

Temperature

Operation: -25°C to 70°C

Storage: -40°C to 85°C

Humidity

5% to 95% non-condensing.

Position

Acuvim II meter and IO modules should be installed in dry and dust free environment and avoid heat, radiation and high electrical noise source.

Installation Method

With the link pins, IO modules are linked to Acuvim II meter and each other. The maximum number of extended modules linked to Acuvim II meter, including IO module, Ethernet module and PROFIBUS module, is three. The communication modules must be installed first. No other module can be installed before them.

1. Insert the installation clips to the counterpart of Acuvim II meter, and then press the IO module lightly, so linking is established.
2. Tighten the installation screw.
3. Install other IO modules by the same way.

Note: 1. lightly in installation or it may cause damage to the IO modules;
2. Installation with power is forbidden.

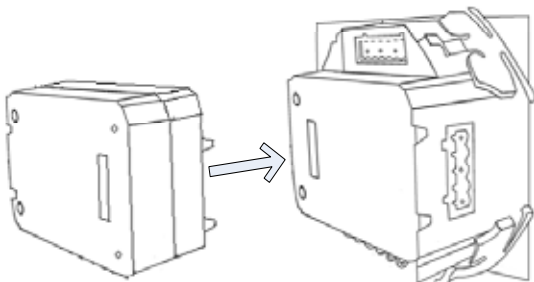

Figure 2-2 Installation of IO modules

2.3 Wiring of IO Modules

Terminal strips of AXM-IO1 module:

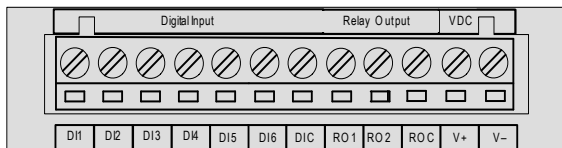

Figure2-3 Terminal strips of AXM-IO1 module

DI1 to DIC: digital input terminals, where DIC is the common terminal for DI1 to DI6 circuits.

RO1 to ROC: relay output terminals, where ROC is the common terminal for RO1 and RO2 circuits.

V24+ and V24-: auxiliary voltage supply terminals.

Terminal Strips of AXM-IO2 Module:

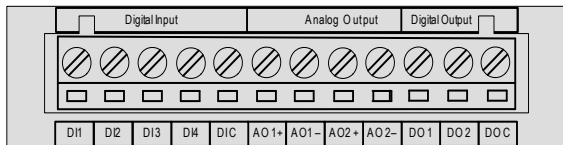

Figure2-4 Terminal strips of AXM-IO2 module

DI1 to DIC: digital input terminals, where DIC is the common terminal for DI1 to DI4 circuits.

AO1+, AO1-, AO2+, AO2-: analog output terminals.

DO1 to DOC: digital output terminals, where DOC is the common terminals for DO1 to DO2.

Terminals strips of AXM-IO3 module:

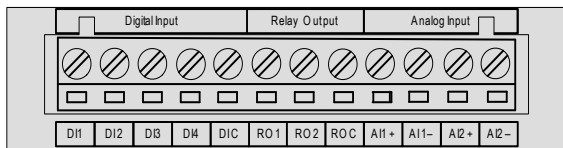

Figure2-5 Terminal strips of AXM-IO3 module

DI1 to DIC: digital input terminals, where DIC is the common terminal for DI1 to DI4 circuits.

RO1 to ROC: relay output terminals, where ROC is the common terminal for RO1 and RO2 circuits.

AI1+, AI1-, AI2+, AI2-: analog input terminals.

Sequence of DI, RO, DO, AO, AI in IO modules (according to the logical

order in the communication address table of the main body):

DI Sequence: AXM-IO11 (AXM-IO1 module in logic NO.1):DI1-6

AXM-IO21 (AXM-IO2 module in logic NO.1):DI7-10

AXM-IO31 (AXM-IO3 module in logic NO.1):DI11-14

AXM-IO12 (AXM-IO1 module in logic NO.2):DI15-20

AXM-IO22 (AXM-IO2 module in logic NO.2):DI21-24

AXM-IO32 (AXM-IO3 module in logic NO.2):DI25-28

RO Sequence: AXM-IO11 (AXM-IO1 module in logic NO.1):RO1-2

AXM-IO31 (AXM-IO3 module in logic NO.1):RO3-4

AXM-IO12 (AXM-IO1 module in logic NO.2):RO5-6

AXM-IO32 (AXM-IO3 module in logic NO.2):RO7-8

DO Sequence: AXM-IO21 (AXM-IO2 module in logic NO.1):DO1-2

AXM-IO22 (AXM-IO2 module in logic NO.2):DO3-4

AO Sequence: AXM-IO21 (AXM-IO2 module in logic NO.1):AO1-2

AXM-IO22 (AXM-IO2 module in logic NO.2):AO3-4

AI Sequence: AXM-IO31 (AXM-IO3 module logic NO.1):AI1-2

AXM-IO32 (AXM-IO3 module in logic NO.2):AI3-4

Wiring of Digital Input Circuit:

There are 6 digital input circuits, 4 digital input circuits and 4 digital input circuits in AXM-IO1, AXM-IO2 and AXM-IO3 modules respectively. The

digital input circuit can be used to detect remote signals, or be used as a counter of input pulses.

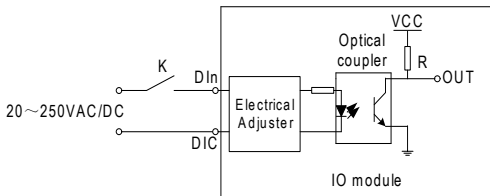

Figure 2-6 schematic diagram of digital input circuit

The circuit drawing of digital input is simplified as figure 2-6. When K is switched off, OUT is in high state. When K is switched on, OUT is in low state.

Auxiliary power supply for the digital input is 20-250 Vad/Vdc. The max current in the loop line is 2mA.

The wire of digital input should be chosen between AWG22-16 or 0.5-1.3mm².

Wiring of Relay Output Circuit:

There are 2 relay output circuits in AXM-IO1 and AXM-IO3 modules respectively. The relay output circuit can work in controlling state, or work in alarm state. When it works in controlling state, it has two optional output modes, latching mode and pulse mode. When it works in alarm state, it has only one latching output mode.

Relay type is mechanical Form A contact with 3A/250Vac or 3A/30Vdc. A mediate relay is recommended in the output circuit as in figure 2-7.

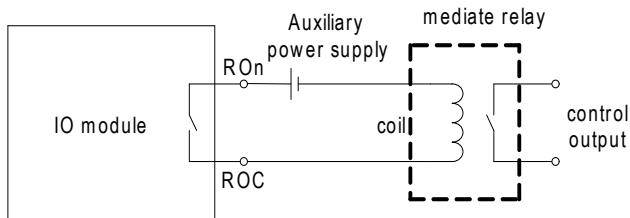

Figure 2-7 schematic diagram of relay output circuit

The wire of relay output should be chosen between AWG22-16 or 0.5-1.3mm².

Wiring of Digital Output Circuit:

There are 2 digital output circuits in AXM-IO2 module. The digital output circuit can work in alarm state, or work in energy pulse output state.

Digital output circuit form is Photo-MOS. The simplified circuit is as figure 2-8.

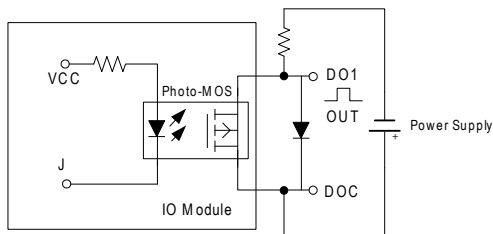

Figure 2-8 schematic diagram of digital output circuit 1

When J is in low state in figure 2-8, OUT is in low state. When J is in high state, OUT is in high state too. So OUT can output pulse signals under the control of J.

The max output voltage and current of digital output circuit are 250V and 100mA respectively.

Another drawing of the alarming output with beeper is as figure 2-9.

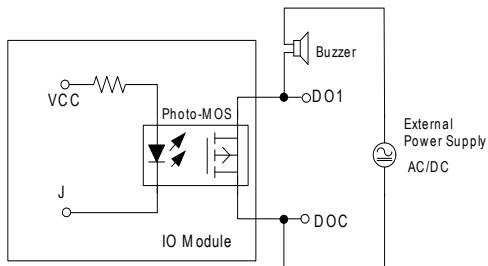

Figure 2-9 schematic diagram of digital output circuit 2

The wire of digital output circuit should be chosen between AWG22-16 or 0.5-1.3 mm².

Wiring of Analog Output Circuit:

There are 2 analog output circuits in AXM-IO2 modules. The terminals of the analog output circuits are AO1+, AO1- and AO2+, AO2-. The analog output circuit can convert anyone of 30 electrical quantities, which is selected by user, to analog voltage or current. The analog output circuit supplies 4 output modes, including 0 to 20mA mode, 4 to 20mA mode, 0 to 5V mode and 1 to 5V mode.

The simplified circuit is as figure 2-10.

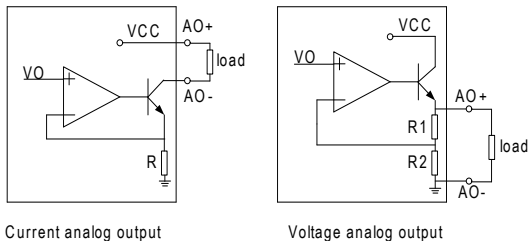

Figure 2-10 schematic diagram of analog output circuit

The Load Capability of Analog Output Circuit:

0 to 20mA mode: the max load resistance is 500Ω .

4 to 20mA mode: the max load resistance is 500Ω .

0 to 5V mode: the max load current is 20mA.

1 to 5V mode: the max load current is 20mA.

Wiring of Analog Input Circuit:

There are 2 analog input circuits in AXM-IO3 modules. The terminals of analog input circuit are AI1+, AI1- and AI2+, AI2-. The analog input circuit supplies 4 input modes, including 0 to 20mA mode, 4 to 20mA mode, 0 to 5V mode and 1 to 5V mode.

The simplified circuit is as figure 2-11.

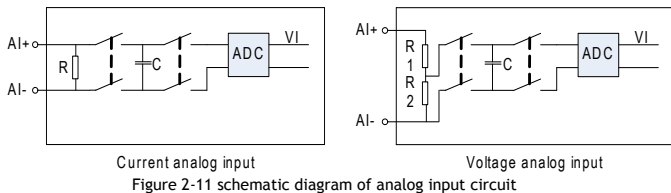

24V Isolated Power Supply:

For the convenience of the factory field used, there is a DI auxiliary power supply provided in AXM-IO1 module. The voltage of the DI auxiliary power supply is 24Vdc (1W). This power supply can not be used for other purpose.

Chapter 3 Function of IO Modules

Detection of Remote Signals

Counter of Pulses

Relay Output

Digital Output

Analog Output

Analog Input

Figure 3-1 shows the function of IO modules, which is explicated in utility software as follows, where AXM-IO12 (AXM-IO1 module in logic NO.2), AXM-IO22 (AXM-IO2 module in logic NO.2) and AXM-IO32 (AXM-IO3 module in logic NO.2) are linked to Acuvim II meter.



Figure 3-1functions of IO modules

3.1 Detection of Remote Signals

The digital input circuit can be set to detect remote signals.

1. Detection of Remote Signals

When digital input circuit detects a qualified voltage input, it will show “1” on screen and “ON” in utility software. Otherwise, it will show “0” on screen and “OFF” in utility software.

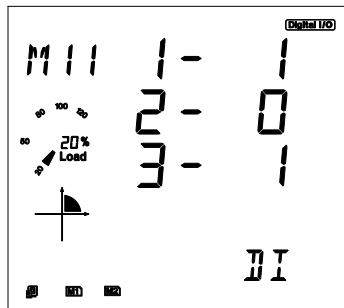

Figure 3-2 showing DI state on screen

2. Record of SOE

When digital input circuit is set to detect remote signals, function of record of SOE can be enabled. So when the remote signals change, IO module can record changing information, such as the time and the change.

SOE Record: including “4399H to 4439H” address registers. “4399H to 4438H” address registers record 20 groups of SOE records. “4439H” records the IO module which generates the SOE records. For example, if register “4439H” is 1, the 20 groups of SOE records are all generated by AXM-IO11 (AXM-IO1 module in logic NO.1).

The 20 groups of SOE records are arranged based on time. When more than 20 groups of SOE records are generated, the records will begin at the first one.

When the Acuvim II meter is powered on, the SOE records will begin at the first one. The data of SOE records will not lose during power off.

When the IO module in which SOE function is enabled is changed, the SOE records will lose.

All group of SOE records have the same data style. Take the first group of SOE records for example, “4399H to 439fH” registers record the time information, including year, month, day, hour, minute, second and millisecond. “43a0H” register records the state information, which is an unsigned integer, where bit 0 records DI1 state, bit 1 records DI2 state, and so on. For example, if “43a0H” is “1”, it means that DI1 is “1”, and others are all “0”.

Note: If one of digital input circuits is set to be counter of pulses when the IO module is SOE enabled, then the counterpart bit of “43a0H” register will always be “0”.

Data of SOE records can only be read by the utility software, it can not be read on screen.

Figure 3-3 shows the data information of SOE records of AXM-IO12 (AXM-IO1 module in logic NO.2) read by the utility software.

No.	Time Stamp	ms	DI 1	DI 2	DI 3	DI 4	DI 5	DI 6
1	2007-6-28 15:20:22	603	OFF	OFF	OFF	OFF	OFF	OFF
2	2007-6-28 15:20:43	969	ON	ON	ON	OFF	OFF	OFF
3	2007-6-28 15:20:43	969	ON	ON	ON	OFF	OFF	OFF
4	2007-6-28 15:20:43	969	ON	ON	ON	OFF	OFF	OFF
5	2007-6-28 15:20:43	969	ON	ON	ON	OFF	OFF	OFF
6	2007-6-28 15:20:49	328	OFF	ON	OFF	OFF	OFF	OFF
7	2007-6-28 15:20:49	328	OFF	OFF	OFF	OFF	OFF	OFF
8	2007-6-28 15:20:04	653	OFF	OFF	OFF	OFF	OFF	ON
9	2007-6-28 15:20:04	654	OFF	OFF	OFF	OFF	OFF	OFF
10	2007-6-28 15:20:00	224	ON	ON	ON	OFF	OFF	OFF
11	2007-6-28 15:20:08	224	ON	ON	ON	OFF	OFF	OFF
12	2007-6-28 15:20:08	224	ON	ON	ON	OFF	OFF	OFF
13	2007-6-28 15:20:15	45	ON	ON	ON	ON	ON	OFF
14	2007-6-28 15:20:15	45	ON	ON	ON	ON	ON	OFF
15	2007-6-28 15:20:15	47	ON	ON	ON	ON	ON	ON
16	2007-6-28 15:20:19	236	OFF	OFF	OFF	ON	ON	ON
17	2007-6-28 15:20:19	239	OFF	OFF	OFF	ON	ON	ON
18	2007-6-28 15:20:19	239	OFF	OFF	OFF	ON	ON	ON
19	2007-6-28 15:20:22	601	OFF	OFF	OFF	ON	OFF	ON
20	2007-6-28 15:20:22	602	OFF	OFF	OFF	OFF	OFF	ON

Newest SOE Record No. 7
SOE Records from AXM IO12

Figure 3-3 data information of SOE records read by the utility software

3. Parameter Setting of Detection of Remote Signals

Take parameter setting of AXM-IO11 (AXM-IO1 module in logic NO.1) for example.

“109eH” register: this register is an unsigned integer, where bit0 determines DI1’s working mode, bit1 determines DI2’s working mode, and so on. If the bit is “1”, then the DI circuit is set to be counter of pulses. Otherwise, the DI circuit is set to detect remote signals. Figure 3-13 shows the parameter setting of digital input circuits.

“101bH” register: this register is an unsigned integer, it determines that which IO module will be SOE enabled. If register is “0”, then any

IO module is SOE disabled. If register is “1”, then AXM-IO11 (AXM-IO1 module in logic NO.1) is SOE enabled. If register is “2”, then AXM-IO21 (AXM-IO2 module in logic NO.1) is SOE enabled. If register is “3”, then AXM-IO31 (AXM-IO3 module in logic NO.1) is SOE enabled. If register is “4”, then AXM-IO12 (AXM-IO1 module in logic NO.2) is SOE enabled. If register is “5”, then AXM-IO22 (AXM-IO2 module in logic NO.2) is SOE enabled. If register is “6”, then AXM-IO32 (AXM-IO3 module in logic NO.2) is SOE enabled. Only one IO module can be SOE enabled at one time. If the IO module is not linked to AcuvimII power meter, then it is meaningless to enable this IO module’s SOE function.

Figure 3-4 shows the parameters setting of IO module’s SOE function.

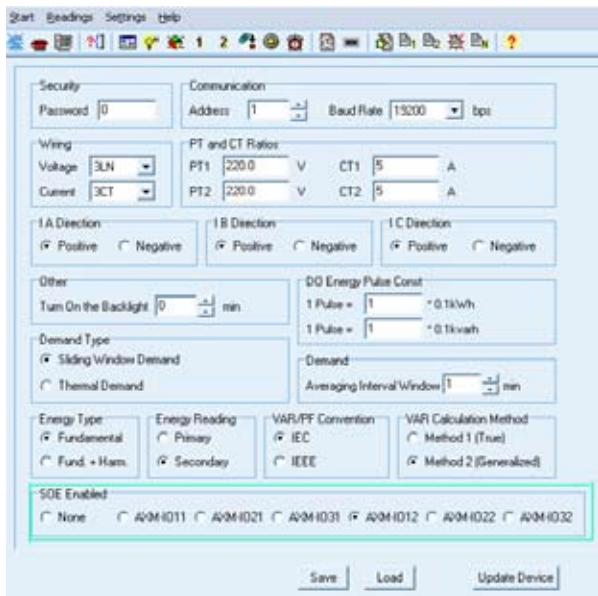

Figure 3-4 parameters setting of IO module's SOE function

3.2 Counter of Pulses

The digital input circuit can also be set to be counter of pulses.

Recorded number of pulses: including “4349H to 4380H” address registers. “4349H to 4380H” registers record 28 groups of number of pulses, including 6 groups of records for AXM-IO11 (AXM-IO1 module in logic NO.1), 4 groups of records for AXM-IO21 (AXM-IO2 module in

logic NO.1), 4 groups of records for AXM-IO31 (AXM-IO3 module in logic NO.1), 6 groups of records for AXM-IO12 (AXM-IO1 module in logic NO.2), 4 groups of records for AXM-IO22 (AXM-IO2 module in logic NO.2) and 4 groups of records for AXM-IO32 (AXM-IO3 module in logic NO.2) in sequence. One group of records is an unsigned long integer, for example, “4349H to 434aH” registers record the number of pulses for DI1 circuit of AXM-IO11 (AXM-IO1 module in logic NO.1).

Figure 3-5 shows the recorded number of pulses read on screen.

Figure 3-6 shows the recorded number of pulses read by the utility software.

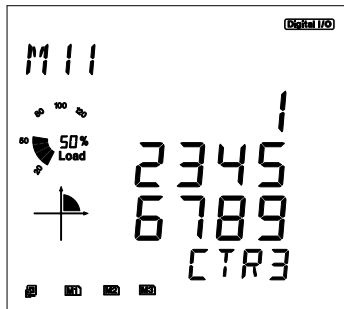

Figure 3-5 recorded number of pulses read on the screen



Figure 3-6 recorded number of pulses read by the utility software

Parameter Setting of Counting of Input Pulses:

Take AXM-1011 (AXM-IO1 module in logic NO.1) for example.

1. “109eH” register: if the bit is set as “1”, the counterpart digital input circuit is set to be a counter of input pulses.
2. “109fH” register: this register is an unsigned integer. If this register is A, and the digital input circuit is set to be a counter of pulses, then the real number of pulses counted by this DI circuit will as follow:

real number of pulses = A × recorded number of pulses.

For example, if A=20, the recorded number of pulses counted by DI1 circuit of AXM-IO11 is 100 (4349H to 434aH registers), then the real number of pulses is $20 \times 100 = 2000$.

The parameter setting is shown in figure 3-13.

3.3 Relay Output

Relays in IO modules can work in two different modes, one is controlling mode, and the other is alarm mode. For controlling mode, relays can be switched on and off directly. For alarm mode, action of relays is controlled by whether the alarm is occurred or not.

There are two modes selection for relay output, one is latching, and the other is pulse. For the latching mode, the relay can be used to output two statuses on or off. For the pulse mode, the output of the relay changes from off to on for a period time T_{on} and then goes off. T_{on} can be set from 50 to 3000ms.

Note: when relay is working in alarm mode, the default output mode is latching mode.

1. Display of Relay State

If relay state is “ON”, it means that relay is switched on. If relay state is “OFF”, it means that relay is switched off.

Figure 3-7 shows the states of relays read on screen.

Figure 3-1 shows the states of relays read by the utility software.

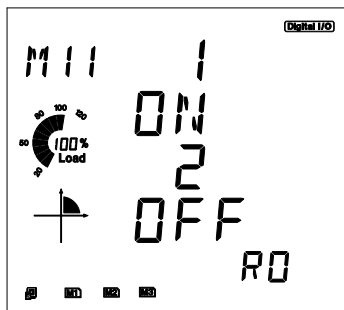

Figure 3-7 states of relays read on screen

2. Parameter Setting

Take AXM-IO11 (AXM-IO1 module in logic NO.1) for example.

“RO working mode (10a0H)” register: this register determines the working mode of relays. If the register is “0”, then RO1 and RO2 will work in controlling mode. If the register is “1”, then RO1 and RO2 will work in alarm mode.

“RO output mode (10a1H)” register: this register determines the output mode of relays. If the register is “0”, then RO1 and RO2 will work in latching output mode. If the register is “1”, then RO1 and RO2 will work in pulse output mode.

“RO pulse width (10a2H)” register: when the relays are working in pulse mode, this register determines the period of time T_{on} which can be set from 50 to 3000ms. For example, if this register is “100”, the relay (RO1 or RO2) will be switched on for 100ms after receiving ON instruction and

then be switched off.

The parameter setting is shown in figure 3-13.

3.4 Digital Output

There are two modes selection for digital output circuit, one is alarm mode, and the other is energy output mode. For alarm mode, action of digital output circuit is controlled by whether the alarm is occurred or not. For energy output mode, digital output circuits can output various types of energy, such as import active energy, export active energy, import reactive energy and export reactive energy. When outputting energy pulses, pulse width can be set from 20 to 1000ms. The minimum interval between two pulses is 20ms.

Parameter Setting:

Take AXM-IO21 (AXM-IO2 module in logic NO.1) for example.

“DO working mode (10a5H)” register: this register determines the working mode of DO circuits. If the register is “0”, then DO1 and DO2 will work in energy output mode. If the register is “1”, then DO1 and DO2 will work in alarm mode.

“DO pulse width (10a6H)” register: when DO circuits work in energy output mode, this register determines the width of energy pulses.

“DO1 output type (10a7H)” register: when DO circuits work in energy output mode, this register determines the energy output type for DO1. If this register is “0”, DO1 outputs nothing. If this register is “1”, DO1 outputs import active energy. If this register is “2”, DO1 outputs export active energy. If this register is “3”, DO1 outputs import reactive energy. If this register is “4”, DO1 outputs export reactive energy.

“DO2 output type (10a8H)” register: when DO circuits work in energy output mode, this register determines the energy output type for DO2. The value of this register is defined as the same as “DO1 output type” register.

“DO1 output type” register and “DO2 output type” register can be set to the same value or not.

The parameter setting is shown in figure 3-13.

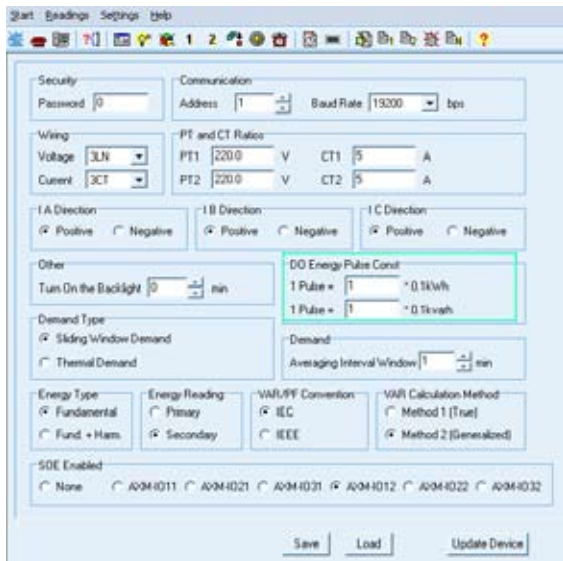

Figure 3-8 parameter setting of DO energy pulse constant

When DO circuits work in energy output mode, parameters of DO energy pulse constant should also be set correctly, which include “active pulse constant (100aH)” and “reactive pulse constant (100bH)”, as shown in figure 3-8.

The value of pulse constant should satisfy following expression:

$$\text{Pulse constant} > \left(\frac{\text{DO Pulse Width}}{20} + 1 \right) \times \frac{P_{\text{max}}}{18 \times 10^6}$$

In the expression, the “Pmax” is the maximum power or reactive power. The unit is watt or var. Recommend pulse constant is 3 to 5 times the right side value of the above expression.

3.5 Analog Output

1. Analog Output Relationship with Electrical Quantities

The analog output circuit can convert anyone of 30 electrical quantities (reference to Acuvim II User’s Manual), which is selected by user, to analog voltage or current.

The analog output circuit supplies 4 output modes, including 0 to 20mA mode, 4 to 20mA mode, 0 to 5V mode and 1 to 5V mode.

Figure 3-9 shows the relationship between analog output and various electrical quantities.

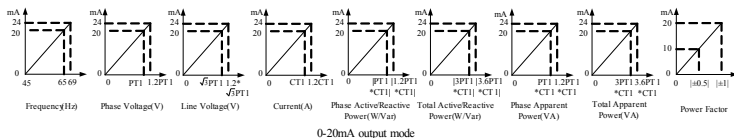

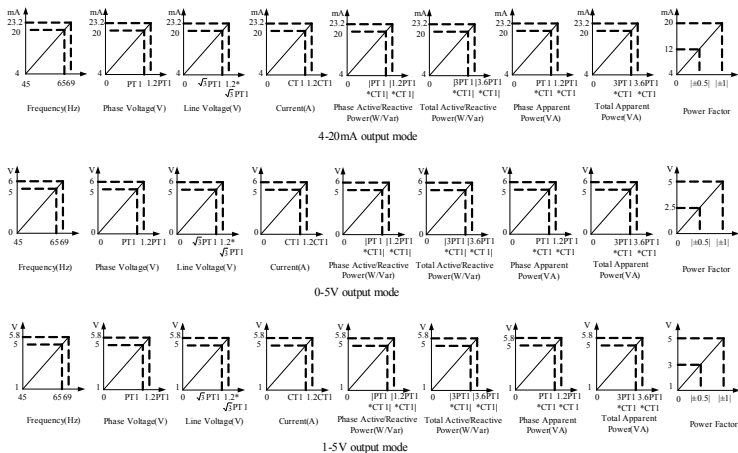

Figure 3-9 Relationship between analog output and various electrical quantities

There are something important to be noted.

- a> If the voltage input wiring of AcuvMI power meter is 2LL or 3LL, then the analog output relative to phase voltage, neutral current, phase active/reactive/apparent power and phase power factor will always be 0.
- b> The maximum of analog output is 1.2 times the range, except when analog output is relative to power factor.

2. Display of Analog Output

Value of analog output is displayed in hex on screen. The relationship between displayed value and real value of analog output is:

$$\text{Real value} = \frac{\text{Displayed Value}}{4096} \times 20\text{mA (current output mode)}$$

$$\text{or } \text{Real value} = \frac{\text{Displayed Value}}{4096} \times 50\text{V (voltage output mode)}$$

As shown in figure 3-10, the displayed value of AO1 is 0x0800, so the real value of AO1 is $(0x0800/4096) \times 5\text{V}$ or $(0x800/4096) \times 20\text{mA}$.

Figure 3-10 shows the displayed value of analog output read by the utility software.

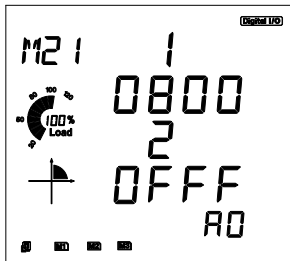

Figure 3-10 AO value read on screen

3. Parameter Setting

Take AXM-IO21 (AXM-IO2 module in logic NO.1) for example.

“Electrical quantities relative to AO1 (10c2H)” register: this register determines which electrical quantity AO1 should be relative to. It is explicated in Acuvim II User’s Manual. For example, if this register is “0”, then AO1 is relative to “Frequency”.

“Electrical quantities relative to AO2 (10c3H)” register: this register

determines which electrical quantity AO2 should be relative to. The value of this register is defined as the same as “Electrical quantities relative to AO1 (10c2H)” register.

“Electrical quantities relative to AO1 (10c2H)” register and “Electrical quantities relative to AO2 (10c3H)” register can be set to the same value or not.

The parameter setting is shown in figure 3-11.



Figure 3-11 Parameter setting of IO modules

3.6 Analog Input

1. Data Dispose of Analog Input

Analog input circuits supplies 4 types of input modes, including 0 to 20mA mode, 4 to 20mA mode, 0 to 5V mode, and 1 to 5V mode.

Figure 3-12 shows the relationship between AI value and input analog value.

AI value is ranged from 0 to 4095 without any unit. AI value is displayed in hex on screen.

Figure 3-13 shows the AI value read on screen.

Figure 3-1 shows the AI value read by the utility software.

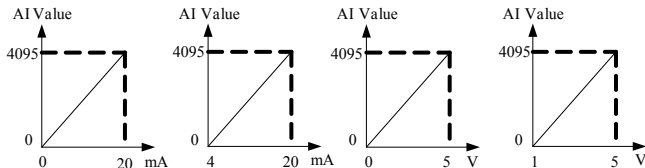

Figure 3-12 relationship between AI value and input analog value

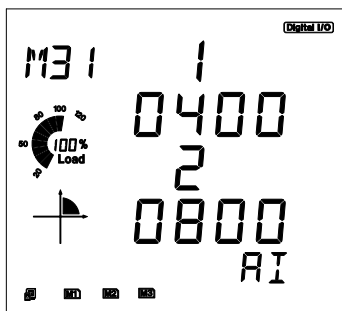

Figure 3-13 AI value read on screen

Appendix

Appendix A Technical Data and Specifications

Appendix B Ordering Information

Appendix C Revision History

Appendix A Technical Data and Specification of IO Modules

Digital inputs (DI)	
Input Type	Wet contact (Contact with power supply)
Input Voltage Range	20-250Vac/dc
Input Current Draw (Maximum)	2mA
Turn on Voltage	20V
Turn off Voltage	5V
Maximum Input frequency for counter	100Hz with 50% duty cycle (5ms ON, 5ms OFF)
SOE resolution	2 ms
Isolation Voltage	2500V

Digital Output AC DC Rating (Photo-MOS)	
Output Form	Form 1A
Load Voltage Range	0-250Vac/dc
Load Current	100mA (Maximum)
Maximum output frequency	25Hz with 50% duty cycle (20ms ON, 20ms OFF)
Isolation Voltage	2500V

Relay Output Rating (RO)	
Output Form	Form 1A
Load voltage Range	250Vac, 30Vdc
Load Current	3A
Turn on Time	10ms (Maximum)
On-state Impedance	100mΩ (Maximum)
Isolation Voltage	2500V
Expected Mechanical Life	15 million

Analog Output Ratings (AO)	
Output Voltage/Current Range	0-20mA/4-20mA, 0-5V/1-5V user selectable
Accuracy	0.5% full scale
Temperature Drift	50ppm/°C typical
Open Circuit Voltage	15V
Isolation Voltage	500V

Analog Input(AI)	
Input Voltage/Current range	0-20mA/4-20mA, 0-5V/1-5V user selectable
Resolution	16bit
Accuracy	0.2% full scale
Maximum Input Voltage/Current	Voltage: 5V; Current:20mA
Temperature Drift	50ppm/°C typical
Isolation Voltage	500V

Internal 24V Power Source	
Output Voltage	24Vdc
Output Current	42mA (Maximum)
Maximum Load	21digital inputs

Standards	
Safety	IEC 61010-1, UL 61010-1
EMC	IEC 61000-4/-2-3-4-5-6-8-11

Suitable Condition	
Operating Temperature	-25°C to +70°C
Storage Temperature	-40°C to +85°C
Humidity Rating	5% to 95% non-condensing
Weight	AXM-IO1: 90g; AXM-IO2: 80g; AXM-IO3: 85g
Power Consumption	AXM-IO1: 1W; AXM-IO2: 1.3W; AXM-IO3: 0.8W

Appendix B Ordering Information

IO Modules Ordering Information:

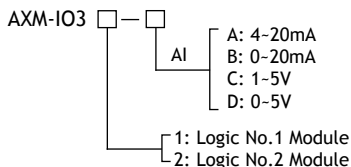
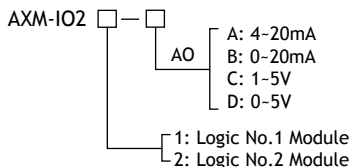
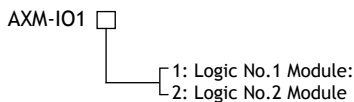

Note:

1. The same IO module can't be used exceed 2 piece at one Acuvim II, and the 2 same IO modules must be different logic NO.
2. The accessory module can't be used exceed 3 piece at one Acuvim II, and the communication modules should be installed nearby the backside of Acuvim II.

Appendix C Revision History

Revision	Date	Description
1.0	20070915	First released.
1.10	20080317	AO parameters revised, apply for manuals of V1.20 and higher version.
1.11	20080701	Additional order information.
1.30	20080912	Change the type of AO and AI setting mode, and relationship figure of AO with some measurements.

Your Power and Automation Partner

ACCUEVERGY

Accuenergy Corp
400 Continental Blvd Suite 600
El Segundo, CA 90245, USA
<http://www.accuenergy.com>

Beijing Accuenergy Technology Co., Ltd. (Manufacturer)

1/F Bldg 3, No.8 Shangdi Chuangye Rd, Haidian District,
Beijing 10085 P.R.China
Tel: +86-10-51290033
Fax: +86-10-62972073